

ZANUSSI

**Instructions
for the use and care of
Microwave Oven
MW600**

It is most important that this instruction book should be retained with the appliance for future reference. Should the appliance be sold or transferred to another owner, or should you move house and leave the appliance, always ensure that the book is supplied with the appliance in order that the new owner can be acquainted with the functioning of the appliance and the relevant warnings.

Warnings – Microwaves

THESE WARNINGS ARE PROVIDED IN THE INTEREST OF SAFETY. YOU MUST READ THEM CAREFULLY BEFORE INSTALLING OR USING THE APPLIANCE.

- This appliance is designed to be operated by adults. Children should not be allowed to tamper with the controls or play with the product.
 - Any electrical work required to install this appliance should be carried out by a qualified electrician.
 - This product should be serviced by an authorised Zanussi Network Service Centre, and only genuine Zanussi spare parts should be used.
 - It is dangerous to alter the specifications or modify the product in any way.
 - Do not overcook food. Overcooking certain food can result in dehydration and subsequently fire. Jacket potatoes and food with a high sugar content – such as those containing dried fruits – are particularly vulnerable. In case of fire unplug the oven and do not open the door.
 - Care and cleaning of the appliance are important. Food deposits should not be left on the interior cabinet. Do not place any object between the oven front face and the door, or allow the door seals to accumulate dirt.
 - Always be careful when removing protective film from food after cooking as the steam when released can cause burns.
 - Any foodstuffs with a «skin», e.g. potatoes, sausages etc, must be pierced before cooking in order to allow for the release of steam.
 - Under no circumstances should live animals be placed in a microwave.
 - Unplug the appliance if it is to be left for a period of time, e.g. during holidays or long weekends.
 - Bases of microwave browning dishes and similar cooking vessels get very hot. Care should be taken that the dish does not come into contact with any plastic surface. Wear protective gloves.
 - Please be cautious when eating food direct from the microwave as items with a high sugar or fat content can be very hot inside.
 - Only use cooking containers recommended for use in a microwave.
 - Do not use metal containers, metal glazed china, melamin or cut glass as cooking containers, or bags with metal ties.
 - Do not use more than the recommended quantities of aluminium foil in the oven.
 - Do not use capped bottles, jars or tins.
- Do not use the oven for drying any items.
- Leave the oven empty at all times when not in use and do not operate the oven when empty.
 - Do not let the timer continue to operate after removing the food.
 - Do not attempt to cook or reheat eggs in their shells, they may explode. Pierce egg yolks.
 - Do not attempt to deep fat fry in a microwave.
 - Do not operate the oven if it is damaged in any way. Under no circumstances should you attempt to repair the appliance yourself. Repairs carried out by inexperienced persons may cause serious injury. Consult your local Zanussi Network Service Centre. Always insist on genuine Zanussi spare parts.

Contents

BASIC OVEN FEATURES	3
INSTALLATION AND ELECTRICAL CONNECTION	4
Important Facts You Should Know	5
FEATURES	6
USING THE MICROWAVE OVEN	8
The Time of Day Clock	8
Microwave Cooking with Time or Temperature	8
Tips On Using the Microwave Oven	9
OVEN OPERATION	10
The Variable Power Feature	10
Operating with Time and Variable Power	11
OPERATING WITH TEMPERATURE, (FOOD TEMP. PROBE & AUTOMATIC HOLD-WARM)	12
Operating with Temperature	13
How to Insert Food Temperature Sensor in Meats	15
Tips for Using the Food Temperature Probe	16
COOKING WITH MEMORIES	18
Using Delay Start	21
The Timer	22
Speed Defrost with Memory	22
CLEANING AND MAINTENANCE	23
QUESTIONS AND ANSWERS	24
WHAT HAPPENS IF SOMETHING GOES WRONG	25

Important: the use of this new appliance is quite simple.

However, to obtain the best results, it is recommended that you carefully read this handbook and follow all instructions prior to operating the appliance for the first time. This handbook provides all necessary instructions for a correct installation, use and care of the appliance and also gives a number of useful hints.

**UNDER NO CIRCUMSTANCES SHOULD ANY SERVICE REPAIR
WORK BE CARRIED OUT ON THIS APPLIANCE
BY UNQUALIFIED PERSONS.**

Basic Oven Features

With your new microwave oven, you can enjoy the speed and convenience of a compact microwave oven. Be sure to carefully read this Use and Care Manual and your cookbook to learn how to fully use and enjoy the oven.

Microwave cooking enables you to cook, reheat, roast, simmer, hold-warm and even defrost with speed and convenience. Because microwave cooking is cool cooking, ovens and dishes are easy to clean. Food is tasty and attractive. Basic cooking techniques are as important when microwave cooking as they are in conventional cooking. These basics are described throughout your cookbook.

Start with something easy; heat a cup of coffee in a mug for 1½ minutes; but open the door at any time and check if the coffee is as hot as you like it. Next, try heating leftovers on a dinner plate. An average serving takes about 3-4 minutes; look for steam or touch the food. Casseroles and vegetables are also easy things to do. Wait until you are comfortable with microwave cooking before you try a roast. Open the door, look and taste the food at any time while cooking so you get the results you like. If additional time is needed, add time gradually; usually about 1/8th of the original time is a good starting point.

Use your cookbook to learn about microwave cooking and use your Use and Care Manual to learn how to operate your oven.

The following is a brief description of the special cooking features of your oven. They are described in more detail throughout the manual.

Variable Power

Allows total flexibility in choosing the speed (microwave power) of cooking which will give you the best cooking results for each type of food.

Food Temperature Probe With Automatic Hold-Warm

Takes the guesswork out of microwave cooking by allowing you to cook to an internal temperature. To be used when cooking joints, beverages, soups and sauces, when the selected temperature is reached the "warm" setting will take over to hold the food until it is required.

Touch Control With Memories

Your touch control feature allows you the benefit of easy cleaning with the flexibility of programmed cooking with memories. You can programme your oven at one time to automatically change power setting, time or temperature and remind you to stir or add ingredients.

Time of Day Clock

The time of day clock functions on a 12 hour cycle (not 24 hour) and is always ready with the time of day whether your oven is in operation or not.

Delay Start

You can programme your oven up to 12 hours in advance (including cooking time) and walk away. Food will be hot and tasty when you want it.

Specifications

POWER SOURCE

240 volts A.C. 50Hz
3 wire grounded circuit

POWER CONSUMPTION

1300 watts/output power
-600 watts

OSCILLATING FREQUENCY

2450 MHz

EXTERIOR DIMENSIONS

Height 32.4 cm
Width 52.1 cm
Depth 38.8 cm

INTERIOR DIMENSIONS

Height 19.1 cm
Width 37.2 cm
Depth 30.5 cm

WEIGHT

19 kg

Installation

To install your oven follow these three steps:

- 1) Remove all materials from the oven interior.
- 2) Place the oven in a location of your choice. Make certain that the oven is on a level surface and that there is at least one inch (2.5cm) of clearance at the top, 1½ inch (4cm) at the back and a total of 6 inches (15cm) side clearance to ensure proper ventilation. Note: Do not store cookbooks or this instruction manual inside or underneath the oven.
- 3) Make the electrical connection as detailed below.

Electrical connection

- 1) The microwave oven incorporates a plugtop suitable for the load and voltage shown on the rating plate.
- 2) The plug moulded onto the cord incorporates a fuse. For replacement, use a 13 Amp BS 1362 fuse. Only ASTA approved fuses should be used. The fuse cover/carrier must be replaced in the event of changing fuse.
- 3) The right fuse cover/carrier colour is the one shown by the coloured insert at the base of the plug. The plug must not be used if the fuse cover/carrier is lost.
- 4) A replacement cover/carrier must be obtained from Zanussi Service Agents whose addresses are listed on the attached "Zanussi Network Service & Spares Leaflet".
- 5) If the plug is not suitable it must be cut off and the appropriate plug fitted. The cut off plug should be disposed of to prevent the hazard of electric shocks in case it should be plugged into a 13 Amp socket in another part of your home.
- 6) **Important:** The wires in this mains lead are coloured in accordance with the following code:

GREEN AND YELLOW — Earth
BLUE — Neutral
BROWN — Live
- 7) If you fit your own plug, the colours of the wires in the mains lead of your appliance may not correspond with the markings identifying the terminals in your plug, this is what you have to do: connect the green and yellow (earth) wire to the terminal in the plug which is marked with the letter "E" or the earth  symbol or coloured green, or green and yellow.

Connect the blue (neutral) wire to the terminal in the plug which is marked with the letter “N” or coloured black.

Connect the brown (live) wire to the terminal which is marked with the letter “L” or coloured red.

8) **This appliance must be earthed.**

Before the appliance is connected check that: the fuse and the domestic installation are suitable to carry the electric load of this appliance (see the rating plate); the power supply is properly earthed according to existing rules and regulations.

9) **The manufacturers disclaim any responsibility should these safety instructions not be carried out.**

10) Important: After installation and electrical connection of the appliance, place the cable in such a way that it cannot at any point reach a temperature more than 50°C above the ambient temperature.

11) Warning: For reasons of safety it is strictly forbidden to remove the rear panel to gain access to the oven terminal board; any extension should only be made by using the standardized plug and the external cable, and it should be suitable to carry the expected load.

12) The appliance meets the requirements laid down in EEC Directive No. 76/889 dated 4/11/1976 relating to the suppression of radio and TV interference.

Important Facts You Should Know

Safety Precautions

Do Not attempt to operate the oven with the door open by tampering with the safety interlocks.

Do Not place any object between the oven front face and the door or allow the sealing surfaces to accumulate dirt.

Do Not operate the oven if it is damaged in any way.

Do Not attempt to have the oven adjusted or repaired by anyone other than properly qualified personnel.

Cookware

As microwaves heat only the food, it is possible to serve in the same dish you used for cooking. The dish is warmed only slightly through the heat of food. You can cook in almost any type of ceramics except those with gold, silver or platinum decoration. However, it is recommended to use completely baked ceramic dishes.

Any heat-resistant cookware can be used. However, care should be taken when using fragile glassware since abrupt heating and cooling may break them.

Some plastics, such as melamine or urethane, are not recommended because microwaves may warp or crack them through heating by microwaves or conduction of heat from the food. For further information, see your microwave cook book.

Some tips on cooking

The microwave oven cooks much faster than conventional ovens. You will have to rely more on the times than on the appearance because the food is cooked inside and out almost simultaneously. Check the food periodically until you become familiar with this modern way of cooking. Remember the cooking time may require adjusting according to your taste and because the food itself will vary in weight, tenderness and shape.

Features

Stirrer Cover

This plastic cover protects the microwave stirrer blades from soil or bending. Stirrer cover should not be removed.

Safety Interlock System

Interlocking system which assures the oven cannot be operated with the door open. Automatically shuts the oven off when the door is opened.

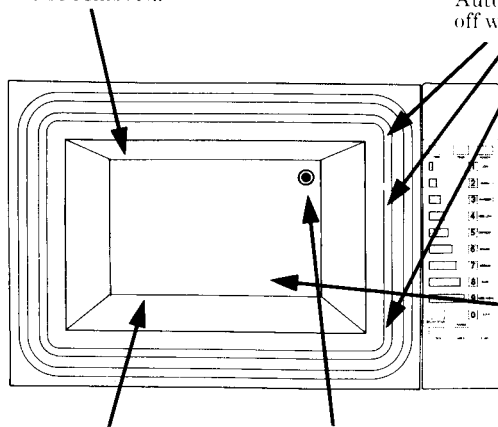

Touch Control Panel

Touch control panel for easy cleaning and programme flexibility; (more detailed picture on next page).

Easy Clean Interior

Splatters are easily wiped out with soap and water, leaving a clean finish.

Sealed-In Ceramic Shelf

The durable ceramic shelf is sealed in for easier cleaning.

Probe Plug Socket

Where probe plug is inserted when cooking with temperature.

Food Temperature Probe

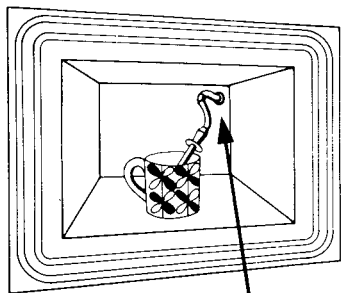

PROBE PLUG SOCKET

SENSOR — First 12 mm of pointed metal portion of probe that is inserted or placed into food to sense internal temperature.

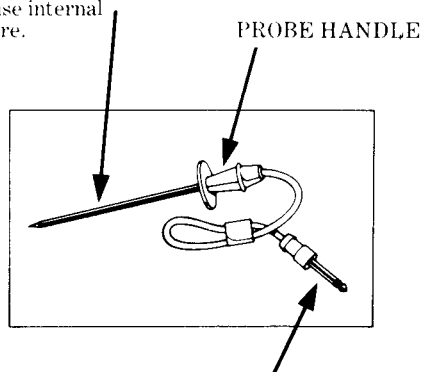

PLUG — End of temperature probe that is inserted into probe socket.

Touch Control Panel

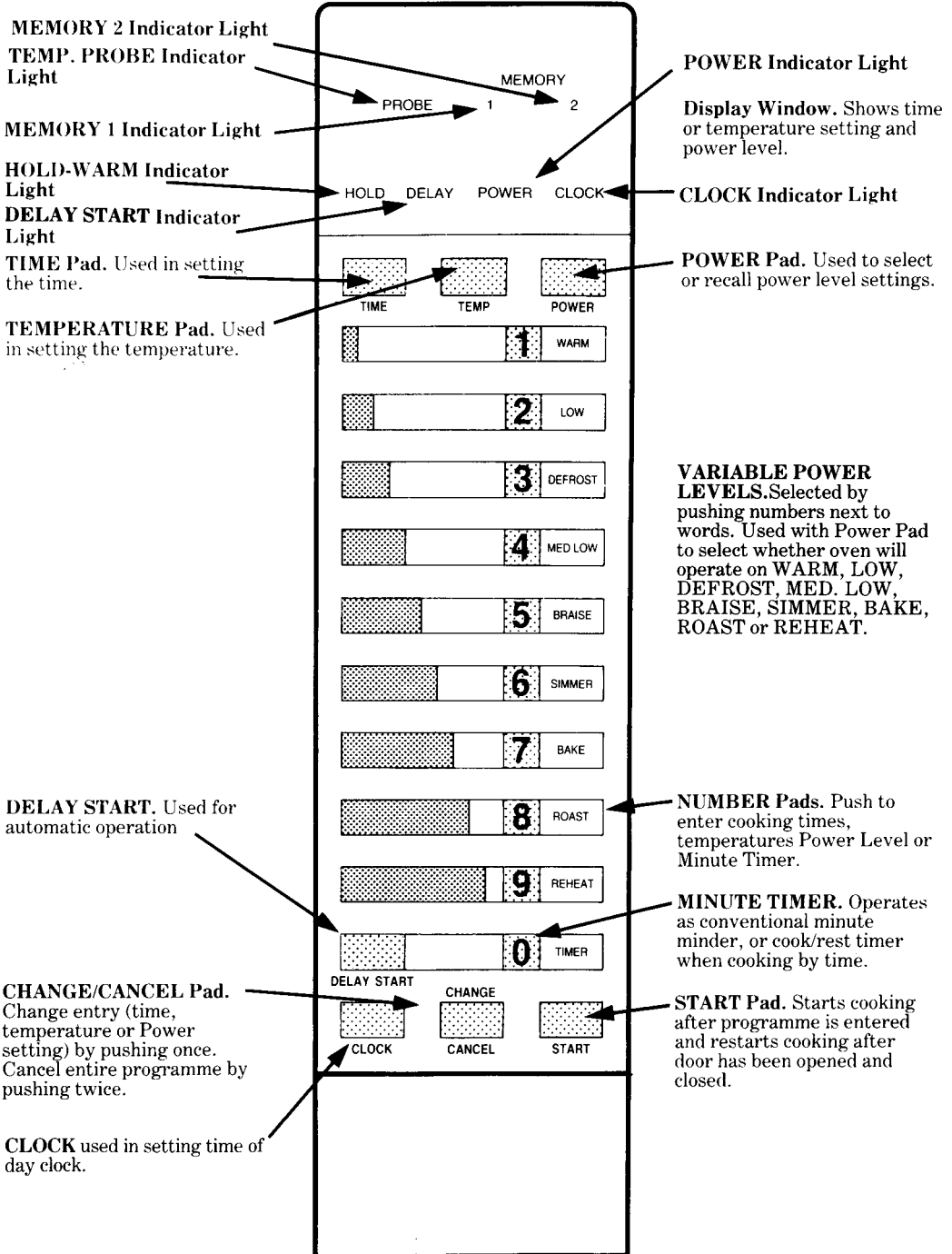

Using the Microwave Oven

To ensure maximum satisfaction from your microwave oven we would like to advise you of some precautions to observe when using your new microwave cooking appliance.

Before using for the first time be sure that all packing materials are removed.

Do Not use the oven for storage when it is not in use.

Do Not attempt to run the oven with no food in it.

Do Not let the timer continue to operate after removing a food, return the timer to zero.

Do Not attempt to cook or reheat eggs in the shell in the microwave oven: they may explode.

Above all, this is a cooking appliance designed to prepare food. Whilst microwave ovens do not generate heat to cook food the food item and possibly the container may become hot. Therefore precautions that are taken with conventional cooking should also be observed when cooking with microwaves.

The Time of Day Clock

- After plugging in the oven or after a power cut the Display will be blank. Set clock using the following instructions.
- If set, the time of day will always be displayed when no other cooking function is being used.
- If Time of Day Clock is not set, a colon will appear in the Display for 5 minutes after cooking, then the Display will be blank.

- To check the time of day when programming your oven or cooking, push the CLOCK Pad. Time of day will be displayed until the START Pad is pushed.

Setting the Clock

1. PUSH CLOCK PAD. Clock Indicator Light will come on. If changing, already operating Time of Day Clock, no change occurs in the Display Window.
2. PUSH CHANGE/CANCEL PAD ONCE. If setting the clock for the first time, no change will occur in the Display Window.
3. SET THE TIME OF DAY BY PUSHING THE APPROPRIATE NUMBER PADS. The time you set will appear in the Display Window.
4. PUSH START PAD. The Time of Day Clock will not be activated until the START Pad is pushed. Time will change in one minute increments.

Microwave Cooking With Time or Temperature

Microwave cooking is controlled with either time or temperature. Microwave with temperature is ideal when the internal temperature is the indication of doneness, such as roast or beverage. (Detailed instructions for microwaving with temperature are on pages 13 & 14). Use time when visual appearance, taste or touch is the indication of doneness, such as a potato, cake or sauce. (Detailed instructions for microwaving with time are on page 11).

Tips on Using the Microwave Oven

- Be sure to carefully read your cook book and become familiar with the results to expect.
- Always start with the minimum cooking time given in the book and add time as needed to obtain the doneness desired. Each recipe gives you a suggested cooking time and indication of doneness. Use the cooking time as a guide and follow the doneness test carefully.
- The door can be opened any time during the cooking operation; the oven will automatically stop cooking and the time or temperature setting will maintain until the door is closed and the START Pad is pushed.
- A microwave oven is used for defrosting, heating or cooking foods. It should not be used for such things as drying non-food items such as flowers, canning, or cooking or reheating hard cooked eggs with or without the shell.
- Be sure to read each recipe carefully as dish size, arrangements, stirring, and standing time are important in obtaining good results.

Oven Operation

The Variable Power Feature

Variable power includes settings from 100% (HIGH) or full power to 10% (WARM). The 100% setting provides the greatest speed of microwave cooking. The settings between 100% and 10% represent decreasing amounts of microwave speed. The cookbook supplied with your oven describes which setting to use for each type of food.

This feature gives you total flexibility in choosing the speed (or microwave power) of cooking which will give you the best result for each type of food. As with conventional cooking, some foods require slower or more gentle microwave cooking. Other foods need to cook slower so heat from the outside has enough time to conduct into the centre of the food.

Variable Power gives you the flexibility to choose the microwave speed that is right for the food you're cooking.

Basic uses are as follows:

10% WARM

Softening cheese and butter, raising bread, holding food warm.

20% LOW

For small amounts of food you want to cook very slowly, clarify butter, melt chocolate, heat prebaked breads, pancakes, pastries.

30% DEFROST

Defrosting meats, poultry, fish and frozen convenience foods.

40% MED. LOW

Warming syrups and sauces.

50% BRAISE

Use for slow cooking of less tender cuts of meats.

60% SIMMER

Stews and soups, to start quick breads and cakes.

70% BAKE

Cakes and quick breads will cook fast.

80% ROAST

Roast beef, meatloaves, ham.

90% REHEAT

Reheating precooked foods and leftovers.

100% HIGH

Full power for vegetables, fish, hot beverages, grill. Preheating microwave browner.

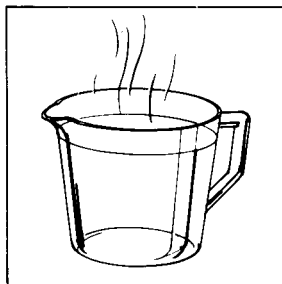

WARM

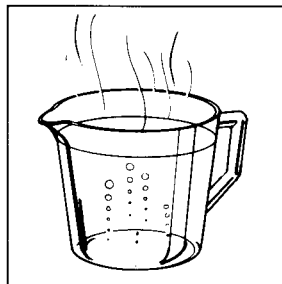

SIMMER

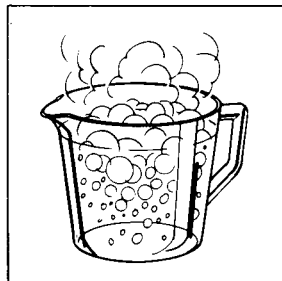

HIGH

Operating with Time & Variable Power

Each recipe in the cookbook gives the approximate cooking time. Start with the shorter time and add time if needed. The cookbook is only a guide, as food temperature and density can vary the time.

- 1 OPEN DOOR:** Interior light comes on.
- 2 PLACE FOOD IN OVEN, CLOSE DOOR:** The light will go off. The oven is now ready to programme.
- 3 PUSH THE TIME PAD:** A colon will appear in the display and the indicator for “Memory 1” will be displayed.
- 4 SET THE DESIRED TIME:** Push the appropriate Number Pads. The time will appear on the Display. For example, to set the time for 5 min. 30 secs., press 5,3,0.
- 5 PUSH THE POWER PAD:** “HI” appears in the Display Window. This is to remind you that the oven will always operate at full power unless you change the Power Setting. The indicator for Power will be displayed.
- 6 SELECT THE POWER SETTING YOU DESIRE:** Push the Number Pad next to the desired setting. For example, if the recipe calls for cooking at the SIMMER setting you would push number “6” (the number next to SIMMER on the panel). The Display will read “60”. This means that the oven is operating at 60% of full power.
- 7 PUSH THE START PAD:** Time will begin to count down. A tone sounds three times when the time is up. The oven automatically stops cooking and the oven light and fan will switch off.
- 8 OPEN DOOR, REMOVE FOOD. CLOSE DOOR.**

To Check

Power Setting

1. Push Power Pad. Variable power setting will appear in Display.
2. Push START Pad to return to time counting down.

To Change

Time

1. Push TIME Pad.
2. Push CHANGE/CANCEL Pad once, Display will clear.
3. Enter new time.
4. Push START Pad and oven will resume operation with new time counting down in Display.

Power Setting

1. Push POWER Pad.
2. Push CHANGE/CANCEL Pad once. “HI” will appear in Display.
3. Enter new Power setting.
4. Push START Pad and oven will resume operation at new Power setting.

Operating With Temperature, (Food Temperature Probe & Automatic Hold-Warm)

The food temperature probe is used as a guide when cooking, reheating, or warming food by temperature. When the probes' sensor is in place in the food and the probes' plug is inserted in the probe plug socket the oven can cook by judging the internal temperature of the food. After the set temperature is reached, the oven will automatically go into a Hold-Warm setting. The temperature probe aids in eliminating guesswork. Pages 15 and 16 of this Use and Care Manual give details on how to insert the food sensor for each food item.

Automatic Hold-Warm

The Hold-Warm feature allows you to keep food warm. Remember that the Hold-Warm will continue to operate until the food and the probe are removed from the oven and the timer has been erased or until 60 minutes has elapsed. As with conventional cooking, prolonged holding can result in overcooking. As a rule, do not hold an item over 1 hour; remember, with microwave speed, it is easy to reheat foods which have cooled off.

Food Temperature Guide

Internal temperature helps tell when food is "done". Temperatures listed below help you judge when food should be taken from a microwave oven.

- 40° — Cured ham, bacon, cured sausage, sandwiches.
- 52° — Rare beef roasts.
- 60° — Fish, meatloaf.
- 64° — Medium beef roasts.
- 66° — Minced beef, precooked main dishes, leftovers, canned vegetables, syrup.
- 68° — Well-done beef roasts.
- 70° — Soups, hot beverages, pork, veal and venison roasts, fresh ham.
- 82° — Poultry, rabbit, well-done leg of lamb.
- 90° — Sauces

Do's and Don'ts

Do insert Food Temperature sensor in thickest part of meat or in the centre of the food to reheat.

Do check that the first 12mm (1/2 inch) of sensor is inserted in the densest part of food to cook.

Do Not operate the oven **empty** with the Food Temperature probe in the oven.

Do Not let Food Temperature sensor touch the sides, bottom, top or door of oven interior when in operation.

Do Not use the probe in a conventional oven. It was specially designed for microwave cooking.

Do Not try to insert Food Temperature sensor in frozen food.

Do Not insert anything into the probe plug socket other than the probe that accompanies your oven.

Do Not clean Food Temperature Temp probe in dishwasher.

Operating with Temperature

After inserting the probe sensor into the food to be cooked:

- 1 OPEN DOOR:** Interior light comes on
- 2 PLACE FOOD IN OVEN:** Insert the temperature probe in the probe plug socket.
Close the oven door.
Oven is ready to programme.
- 3 PUSH THE TEMP. PAD. “C”** (for Centigrade) will appear in display.
- 4 SET THE DESIRED TEMPERATURE:** Push the appropriate Number Pads. The temperature will appear in the Display Window. Temperatures from 34°C to 94°C can be entered. (If temperatures below 34°C or over 94°C are entered a tone will sound and Display will go blank, ready for re-setting of temperature).
- 5 PUSH THE POWER PAD: “HI”** appears in the Display Window. This is to remind you that the oven will always operate at full power unless you change the Power setting. The indicator for Power will be displayed.
- 6 SELECT THE POWER SETTING YOU DESIRE:** Push the Number Pad next to the Power word. For example, if the recipe calls for cooking at the SIMMER setting, you would push number “6” (the number next to SIMMER on the panel). The Display will read “60”. This means that the oven is operating at 60% of full power.
- 7 PUSH THE START PAD: “-34”** will appear in the Display Window (or actual temperature if greater than 34°C) and as the food cooks, the temperature Display will increase in 2 degree increments. When the set temperature is reached a tone will sound three times and the oven automatically reduces power to 10% (Hold-Warm). When in Hold-Warm, the Display will show time counting down from 60 minutes to indicate how long you’ve been in Hold-Warm. The oven will continue to cook in Hold-Warm for 60 minutes or until CHANGE/CANCEL Pad is pushed, or door is opened (interrupts but doesn’t cancel without CHANGE/CANCEL Pad).
- 8 OPEN DOOR, REMOVE PROBE AND FOOD. CLOSE DOOR.**

To Check

Temperature or Power Setting

1. Push TEMP Pad (for temperature) or POWER Pad (for power) and the selected setting will appear on the display.
2. Push START Pad to resume programme.

To Change

Temperature or Power

1. Push TEMP Pad (or POWER Pad if changing Power). Original Temperature (or Power) setting will appear in the Display.
2. Push CHANGE/CANCEL Pad once. If Temperature is being changed, Display will clear. If Power is being changed, "HI" will appear in the Display.
3. Enter new Temperature or Power setting.
4. Push START Pad and oven will resume operation at new Temperature or Power setting.

Meats

ROASTING MEAT KEY: Use fresh meat or frozen meat completely thawed. Place meat on microwave roasting rack set in glass baking dish. Standing times are important to allow meat to finish cooking by conduction. For detailed instructions of roasting meat, consult your cookbook.

How to Insert Food Temperature Sensor in Meats

Boneless meat cuts

The Food Temperature sensor should be placed in the meat from the end and pushed toward centre of the fleshy part.

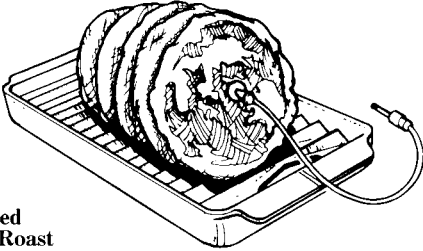
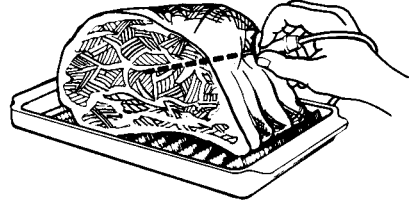

**Roller
Rib Roast**

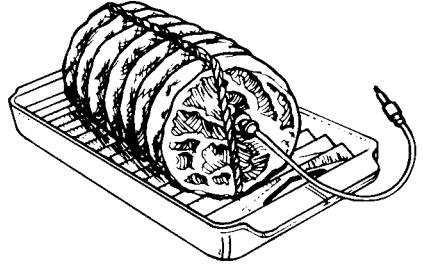

Bone-in meat cuts

Insert the Food Temperature sensor in the fleshy part of the meat. Sensor should not come in contact with bone, marrow or pocket of fat.

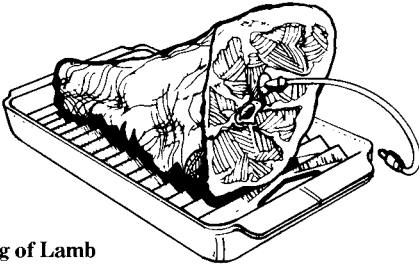

Leg of Lamb

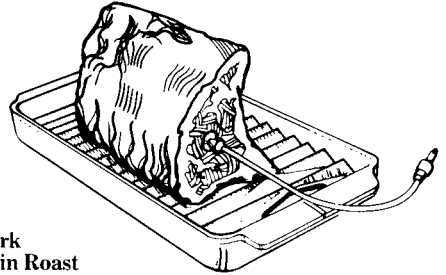

**Pork
Loin Roast**

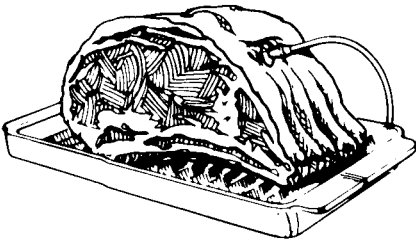

**Standing
Rib Roast**

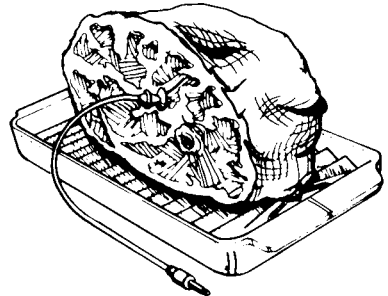

Ham

Tips for Using the Food Temperature Probe

Unless otherwise stated, leave the power level set at high "HI".

APPETIZER: Place food sensor in centre of dip. Tip may touch bottom of dish. Set desired doneness (temperature) 54°C for most dips. Stir before serving.

FROZEN FOOD AND CONVENIENCE

FOOD: Be sure food is completely defrosted before inserting sensor. Insert food sensor in thickest, largest or densest portion of food. A temperature of 65°C is a good reheating temperature for precooked foods. Use REHEAT (90%) setting.

MAIN DISHES: Place food sensor in centre of a meatloaf. Sensor should not touch bottom of pan. Partly cover a casserole dish, if desired, with glass lid to shorten cooking time. Stir casserole before serving if no topping has been added. Standing times allow heat to penetrate food and finish cooking. (Consult cookery book for temperature and power settings).

SAUCE: Place food sensor in sauce. Sensor may touch bottom of dish. Heat to about 65°C.

SEAFOOD: Place food sensor in thickest part of lobster or in centre of the seafood casserole. Set desired final temperature, 70°C -75°C for most fish and seafood.

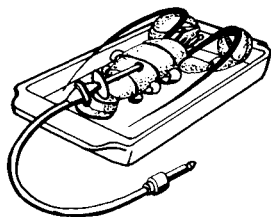
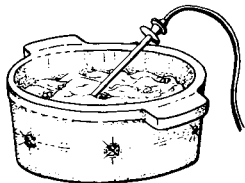

SOUPS AND BEVERAGES: Place food sensor in soup or beverage to be heated; the tip of sensor may touch bottom of dish. A temperature of 65°C or 70°C is ideal for drinking. When additional ingredients are added after heating set the oven to a higher temperature. The liquid soup heats faster, so soups with additional solid ingredients should be heated to a higher temperature. Disposable cups designed for use with hot beverages may be used to heat individual servings.

POULTRY: The probe may be used in whole poultry as just one indicator of doneness. However, because of the variables in cooking whole poultry (size, shape of bird), we suggest the conventional methods of testing doneness be used. Even in conventional cooking, meat thermometers cannot give an accurate measure of doneness of all parts of the bird. When using the probe with whole poultry, insert sensor in thickest part of breast meat. Remember to use conventional doneness tests to assure an accurate measure of doneness of poultry.

The food temperature probe can be used successfully for heating poultry casseroles. Place the sensor in centre of casserole; set desired final temperature (65°-75°C).

VEGETABLES: Place food sensor in centre of precooked vegetable to be heated. Vegetables should be heated to 65°C-75°C.

OTHER FOODS: The food sensor is a great help in the kitchen ... it cooks without guesswork. Use with your favourite recipes, especially those that instruct "DO NOT BOIL" because it allows greater control of temperature.

At times the same kinds of foods may vary in shape, form and density and therefore will not produce the same results each time. For this reason we do not recommend using this feature for thin food items and foods that require tenderizing by simmering.

In some cases the microwave oven may shut off prematurely; this indicates either that the probe is not inserted properly or that it should not be used with this type of food.

Experimenting is the key, so if you decide to use the probe for roasting poultry and cooking other food, remember to complement your evaluation of cooking by the conventional doneness tests.

Temperature Probe Reheating Guide

FOOD	POWER SETTING	TEMP. SETTING	
Beverages	“HI” HIGH	71°C	Place food sensor in centre of beverage glass. As a general rule: 49 to 54 = warm 54 to 66 = medium 66 to 77 = hot
Soups	9 REHEAT	71°C	Place food sensor in the centre of the soup.
Casseroles	9 REHEAT	66°C	Reheat precooked casseroles of uniform consistency. Place food sensor in centre of food.
Meat Sandwiches	9 REHEAT	49°C	Insert food sensor in thickest part of the sandwich to be warmed. The sensitive area of the sensor should be located in the sandwich filling.
Leftovers	9 REHEAT	66°C	Insert food sensor in the densest or largest amount of food.
Canned Vegetables	9 REHEAT	66°C	Place food sensor in centre of food to be microwaved. First 12mm of sensor should rest in middle of product.
Syrup	8 ROAST	66°C	Place food sensor in centre of the container.

Cooking With Memories

The oven has two memories which you can programme with any combination of a variable power setting and time or temperature. Many microwave recipes use different power settings at various times during the cooking process. The memory feature automatically changes power setting, cooking time or temperature. A tone will sound between memories to remind you that the memory is changing. This memory tone and the convenient indicator callouts, will help you know exactly where you are on your recipe. The following are common uses for the memory feature.

- Let the memory tone remind you to stir your sauce or add additional ingredients to a main dish or stew.
- Use memory with Minute Timer to time the rest time after defrosting or cooking.
- Cook a vegetable, then let it stand at zero power as specified in the recipe. The memory tones will tell you when your food is ready to serve.
- Bring your homemade vegetable soup to a boil and then change to SIMMER (60%) to blend the flavours using memories.
- When microwaving cakes, begin the cooking process on BRAISE (50%) to raise the batter and automatically change to HIGH (100%) to finish the cooking and set the cake.
- Programme a memory tone to remind you it's time to baste your chicken.
- Microwave less tender meat on HIGH (100%) to heat it through, then on BRAISE (50%) to cook and tenderize. Memories will change these settings and times for you; the memory tone reminds you to turn the meat, if necessary.

Operating with Memories

- 1 OPEN DOOR: Interior light comes on.
- 2 PLACE FOOD IN OVEN. (If cooking by temperature, insert the food probe plug into probe plug socket and insert sensor into food.) Close door. Oven is ready to programme.
- 3 PUSH THE TIME OR TEMP PAD. The Indicator for "Memory 1" will be displayed.
- 4 SET THE DESIRED TIME (OR TEMPERATURE): Push the appropriate Number Pads. The time or temperature will appear in the Display Window.
- 5 PUSH THE POWER PAD: The Indicator for Power will be displayed and "HI" appears in the Display Window. This is to remind you that the oven will always operate at full power unless you change the Power setting.
- 6 SELECT THE POWER SETTING YOU DESIRE: Push the Number Pad next to the Power words. For example, if the recipe calls for cooking at the BRAISE setting, you would push number "5" (the number next to BRAISE on the panel). The Display Window will read "50". This means that the oven is operating at 50% of full power.

Memory (continued)

To enter next Memory:

- 7 **PUSH THE TIME OR TEMP PAD:** The Indicator showing that you are in “Memory 2” will appear.
- 8 **SET THE DESIRED TIME (OR TEMPERATURE):** Push the appropriate Number Pads. The time or temperature will appear in the Display Window. The “Memory 2” indicator will remain on.
- 9 **PUSH THE POWER PAD:** The Power indicator comes on and “HI” appears in the Display Window. This is to remind you that the oven will always operate at full power unless you change the Power setting.
- 10 **SELECT THE POWER SETTING YOU DESIRE:** Push the Number Pad next to the Power words. For example if the recipe calls for cooking at the BAKE setting, you would push number “7” (the number next to BAKE on the panel). The Display Window will read “70”. This means that the oven is operating at 70% of full power.
- 11 **PUSH THE START PAD:** Time for first memory will start counting down. (If Cooking by Temperature, -34 will appear in the Display for temperature and will increase with the actual temperature.) At the end of the first memory, a tone will sound once and the oven will automatically shift to the next memory. An indicator will remind you that the oven is cooking in the second memory. At the end of cooking, a tone sounds three times.

NOTE:

The oven will automatically stop cooking if cooking with time or will reduce to Automatic Hold-Warm if cooking with temperature. (Remember the oven will continue to operate in Hold-Warm until the food and probe are removed from the oven and the timer has been cancelled or until 60 minutes has elapsed.)

- 12 **OPEN DOOR, REMOVE FOOD, (AND PROBE IF FITTED) CLOSE DOOR.**

To Check

Time or Temperature

1. Push TIME OR TEMP Pad. Time or set temperature will be displayed.
2. Push TIME OR TEMP Pad again; next memory will be displayed.
3. Push START Pad to return to time counting or actual temperature.

Power Setting

1. Push POWER Pad. Power setting will appear in Display.
2. Push POWER Pad again; next power memory will be displayed.
3. Push START Pad to return to time counting or actual temperature.

To Change

Time or Temperature

1. Push TIME OR TEMP Pad until memory to be changed is in the Display.
2. Push CHANGE/CANCEL Pad once.
3. Enter in new time or temperature by touching Number Pads.
4. Push START.

Power

1. Push POWER Pad until memory to be changed is in display.
2. Push CHANGE/CANCEL Pad once. "HI" will appear in Display.
3. Enter new Power setting.
4. Push START Pad and oven will resume operation at new Power setting.

Example for Using and Programming the Memory

Chocolate cake

- 1 Pkt. chocolate cake mix
- 170 ml water
- 1 egg

1. Combine cake mix with water and egg in medium mixing bowl. Beat well with wooden spoon. Spread in 9-inch round glass baking dish.
2. Microwave on BRAISE (50%) for 7 minutes.
3. Microwave on HIGH (100%) for 2-3 minutes or until toothpick inserted near centre comes out clean.

About 6 servings.

To Programme

Memory 1

1. Push TIME Pad.
2. Enter 7:00.
3. Push POWER Pad
4. Enter BRAISE (50%) power.

Memory 2

5. Push TIME Pad.
6. Enter 2.00.
7. Push START Pad.

1st Memory

The first memory will begin the cooking on BRAISE (50%) because the cake needs to start cooking slowly. A memory tone will sound to remind you when the oven changes to the next memory. The indicator provides a visual display.

2nd Memory

The second memory automatically increases the power setting to HIGH (100%) for 2 minutes to quickly finish cooking the cake. A tone sounds three time when the time is up.

Using Delay Start

If you want the oven to start cooking at a later time, use the DELAY START feature to delay cooking up to 12 hours.

Important Delay Start Use Tips

- **SELECT FOODS CAREFULLY.** Foods which require no attention or stirring are best. Do not use foods containing milk, fish, eggs or non-frozen meat or poultry. These foods are perishable and do not hold well. Frozen meats and casseroles are recommended.
- **REDUCE COOKING TIME.** If cooking is being delayed by several hours, reduce cooking time a little because the warmer beginning food temperature will decrease normal cooking time. If food is frozen, remember to set the Memories to DEFROST (30% power), then start cooking.

Operation

- 1 Check to see that the clock is set for the current time of day. If the time of day is not correct, change it, following instructions on page 8. Then place food in the oven and close the door.
- 2 **PUSH DELAY START PAD:** Display Window will show the colon and the Delay Start Indicator Light will come on.
- 3 **SET THE DESIRED START TIME:** Push the appropriate Number Pads for time of day when the food should start cooking.
- 4 **PUSH TIME OR TEMP PAD:** The Display Window will show a colon or a "C" and the Memory 1 Indicator Light will come on. The Delay Start Indicator Light goes off.

- 5 **SET THE AMOUNT OF COOKING TIME OR TEMPERATURE:** Push the appropriate Number Pads. Set Power level by pushing POWER Pad and then the appropriate Number Pad. If 2 Memories are to be used, repeat steps 4 and 5 a second time to programme the second cooking step.
- 6 **PUSH START PAD:** Time of day will appear in the Display Window. Clock, Delay Start and Memory Indicator Lights will be on. The oven will start cooking automatically at the programmed start time. Counting down cooking time will be displayed.
- 7 **CHECK THE SETTINGS:** Push the DELAY START Pad to confirm the starting time. Push the TIME or TEMP Pad and Power Pad to confirm settings.

The Timer

The Timer feature of this oven has many uses. Use it to time standing times after microwave cooking, or mixing or beating times when preparing recipes. By programming the Timer in Memory 1, you can also delay the start of cooking of a food. This is particularly helpful during the last busy minutes before dinner time when you may forget to start cooking a food that only takes a few minutes. When using the Timer feature, there is no microwave energy or cooking in your oven. To use the Timer feature of this oven it is important to carefully follow each of the following steps.

Operation

1. PUSH THE TIME PAD.
2. SET THE DESIRED TIME.
3. PUSH THE POWER PAD.
4. PUSH THE “0” (the number next to the Timer). “00” will appear in the Display Window indicating that there is 0% power.
5. PUSH THE START PAD. Time will begin counting down in the Display Window with no cooking or heating operation of the oven. When time is up, a tone sounds three times. The time of day will appear in the Display Window, if your oven has a Time of Day Clock which has been programmed. Otherwise, the colon will remain on about 5 minutes.

NOTE: If you hear the fan start when the START Pad is pushed, you have not set the Timer properly. Push CHANGE/CANCEL pad twice and follow steps 1—5 above .

Speed Defrost with Memory

Microwaves have a difficult time penetrating frozen foods in the first few minutes and penetrate foods more easily when they are partially defrosted. The defrost time can be speeded by starting with microwave cooking on HIGH and then automatically reducing to the DEFROST setting.

To Speed Defrost With Memory:

1. Microwave on HIGH for 2 minutes per pound of dense food items.
2. Then microwave on DEFROST for 3 minutes per pound or until food is thawed. Defrost time will be greatly reduced.

Example: You would normally defrost a 4 lb. roast on DEFROST for 35 minutes. With Speed Defrost you would need only 20 minutes:

1. Microwave on HIGH for 2 minutes per pound (2 minutes x 4 pounds = 8 minutes).
2. Microwave on DEFROST for 3 minutes per pound (3 minutes x 4 pounds = 12 minutes).

Cleaning & Maintenance

Microwave Oven Cleaning

Your microwave oven requires a minimum of maintenance. To keep it free from grease and soil build-up, the microwave oven should be cleaned with a damp cloth after each use. A soft nail brush can be used to remove stubborn stains. Use only a mild detergent, water and a soft, clean cloth to clean the oven face and interior surfaces. Odours can be eliminated from the inside of the oven by boiling a solution of one cup of water and several tablespoons of lemon juice in the oven for 5-7 minutes. This also helps in loosening any soil which has dried on the oven. Be careful not to scratch the door and interior surface. Wipe out excess moisture after each use. Ceramic cleaners can be used to clean the shelf.

Do Not Use: Abrasive cleaners, cleaning pads or steel wool.

Cleaning the Temperature Probe

Remove the probe from the oven. Wipe food or liquid from the probe with a damp cloth. Dry completely after use and washing. **DO NOT** clean temperature probe in the dishwasher.

Oven Should Not Be Used For Storage

Be sure the oven is cleaned carefully after every use and is not used for storage of paper products, books or cooking utensils.

Replacement of Oven Interior Light

The oven interior light bulb is easily replaced. First, unplug the oven. Then, simply unplug and remove the "Lamp Access Cover" on the back of the oven. In some models, a screw must first be removed to remove the cover. Replace bulb with a 25-watt lamp (E-14) available from a hardware store or local Zanussi service agent.

Lamp Access Panel

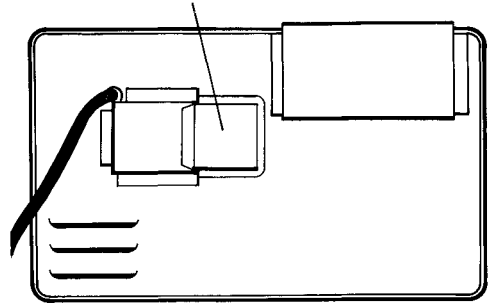

Questions and Answers

- Q.** What happens if I accidentally operate the microwave oven with no food in it?
- A.** While such accidental use of short periods of time does not damage the magnetron, it is not recommended.
- Q.** Is eating food cooked in a microwave oven harmful?
- A.** Microwaves are simply a source of heat energy just like gas and electricity. All three produce cooking in the food itself. Food cooked in a microwave oven is not harmful to eat.
- Q.** Why do I have moisture in the microwave oven after cooking?
- A.** The moisture on the inside of your microwave oven is normal and nothing to worry about. It is caused by the steam from the cooking food hitting a cool oven surface. Wipe excess moisture from inside of oven after each use.
- Q.** What causes the oven interior light to dim when using Variable Power?
- A.** This is normal and indicates that the oven is operating and cycling normally.
- Q.** Foods cooked in a microwave oven seem to cool off faster than conventionally cooked foods. Why is that?
- A.** Often the dish used to store foods in the refrigerator is used for heating in the microwave oven. In this case, the cold dish absorbs heat from the food. It may be necessary to heat the food for additional time.

What happens if something goes wrong

Power cuts

Should the electricity fail for any reason remember to reset the clock to the right time when the power is resumed.

Important:

If the oven does not come on:

check that the appliance is connected correctly;
check that the switch from the supply to the appliance is ON;
replace the fuse in the socket, where present, with another of the appropriate rating;
check that the fuse in the fuse box is intact.

If after all these checks the appliance still does not work, call your local Zanussi Network service centre listed in the telephone directory. It helps to jot down the address and telephone number in the space below.

Never attempt to remove the rear panel of the oven or tamper with the oven in any way.

Important: UNDER NO CIRCUMSTANCES SHOULD ANY SERVICE REPAIR WORK BE CARRIED OUT ON THIS APPLIANCE BY UNQUALIFIED PERSONS.



ZANUSSI STANDARD GUARANTEE CONDITIONS

This guarantee is in addition to your statutory and other legal rights which will not be excluded or in any way diminished by the return of the guarantee card.

We, Zanussi Limited, undertake that if, within twelve months (24 months for TV sets) of the date of the purchase, this ZANUSSI appliance or any part thereof is proved to be defective by reason only of faulty workmanship or materials, we will, at our option, repair or replace the same **FREE OF ANY CHARGE** for labour, materials or carriage on condition that:

—The appliance has been correctly installed and used only on the electricity supply stated on the rating plate.

—The appliance has been used for normal domestic purposes only, and in accordance with the manufacturer's operating and maintenance instructions.

—The appliance has not been serviced, maintained, repaired, taken apart or tampered with by any person not authorised by us.

—The appliance is still in the possession of the original purchaser.

All service work under this guarantee must be undertaken by a Zanussi Network Service Centre (or the Zanussi Authorised TV Service Dealer).

Any appliance or defective part replaced shall become our property.

Exclusions

This guarantee does not cover:

—Damage or calls resulting from transportation, improper use or neglect, the replacement of any light bulbs or removable parts of glass or plastic.

—Costs incurred for calls to put right machines improperly installed or calls to machines outside the UK and the Republic of Ireland.

—Appliances found to be in use within a commercial environment, plus those which are the subject of rental agreements.

—Television receivers - routine adjustment, or poor reception resulting from a source outside of the receiver.



ZANUSSI 5 YEAR COVER CONDITIONS

For a once-only payment you can extend your Standard Guarantee to 5 years. All the conditions and exclusions of the Standard Guarantee apply.

Notes

1. Products supplied as "seconds", refurbished, damaged or shop-soiled are not eligible for Zanussi 5 year cover.

2. The issue of a cover does NOT by virtue of our having done so, nullify the exclusions.

3. The Engineer will need to check the details of your Cover card and may make a charge for his services if it is not presented to him at the time of his call.

4. The date of purchase, or the date of initial payment (deposit) of the appliance will be deemed the date of commencement of cover.

5. Covers issued are not refundable or transferable.

ZANUSSI
The appliance of science